

LD6A Series

Confirm that the delivered product is what you have ordered. Read this instruction sheet to make sure of correct operation. Make sure that the instruction sheet is kept by the end user.

SAFETY PRECAUTIONS

In this operation instruction sheet, safety precautions are categorized in order of importance to Warning and Caution :

**WARNING**

Warning notices are used to emphasize that improper operation may cause severe personal injury or death.

**CAUTION**

Caution notices are used where inattention might cause personal injury or damage to equipment.

**WARNING**

- Read the specifications described on this sheet to make sure that the operating conditions are correct.
- Before designing the final equipment and powering up the LD6A Series, confirm the specifications described on this sheet. If there is any uncertainty in the description, contact IDEC before powering up the LD6A Series.
- Do not disassemble, repair, or modify the LD6A Series, otherwise severe accidents may result, such as electric shocks, damage, fire, or malfunction.
- Make sure that the LD6A Series does not fall during transportation, installation, and operation, otherwise damage may result.
- Do not pull out or push in the cable of the LD6A Series, otherwise damage may result. Give a slack to the cable while wiring.
- Turn off the power to the LD6A Series before mounting, dismounting, wiring, and assembling the LED unit. Make sure of correct wiring, otherwise electric shocks or fire may result.
- All LD6A Series are manufactured under IDEC's rigorous quality control system, but users must add failsafe provision to the control system using the LD6A Series in applications where heavy damage or personal injury may be caused in case the LD6A Series should fail.

**CAUTION**

- Apply a voltage within the rated value.
- Do not apply an excessive force to the LD6A Series. Do not leave a damaged LD6A Series unattended or use a damaged LD6A.
- Make sure of the correct operating temperature, which is the temperature around the LD6A Series. Otherwise internal temperature rise may result in damage.
- Do not use or store the LD6A Series in a place subjected to vibrations and shocks.
- Do not loosen screws, otherwise the protection characteristics will be impaired.
- For use on a flat surface of a Type 1 enclosure.
- Maximum surrounding air temperature rating 55°C.

1 Type

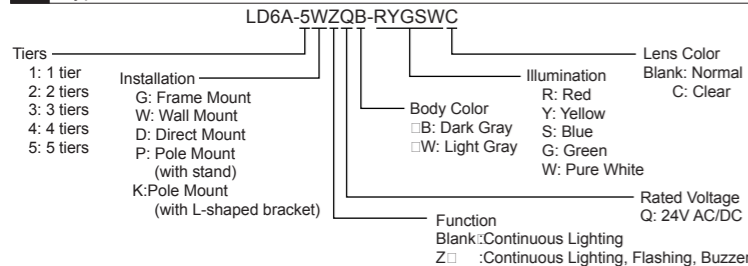

2 Specifications

Rated Voltage	24V AC/DC Class 2
Rated Insulation Voltage	60V
LED Rated Current	Red, Yellow: 25 mA □ Green, Blue: 30 mA □ Pure White: 20 mA
Power Consumption	Red, Yellow: 0.6W □ Green, Blue: 0.75W □ Pure White: 0.5W
Applicable Standard	UL 508, CSA C22.2 No. 14 IEC60947-5-1, EN60947-5-1, JIS C 8201-5-1 □
Operating Temperature *1	-25 °C to +55 °C (no freezing)
Operating Humidity	45 % to 85 % (no condensation)
Storage Temperature	-40 °C to +75 °C (no freezing)
Operating Atmosphere	Free from corrosive gases
Operating Location	Indoor use only
Overvoltage Category	III (IEC 60664-1)
Impulse Withstand Voltage (Uimp)	800V (IEC 60947-1 / JIS C8201-1)
Insulation Resistance	100 MΩ minimum (500V DC megger)
Dielectric Strength	1000V AC, 1 minute (between live and dead parts)
Vibration Resistance (operating extremes)	10 to 55 Hz, amplitude 0.5 mm
Shock Resistance	147 m/s <sup>2</sup> , 6 shocks each in 6 directions
Life *2	30,000 hours (until the brightness reduces to 50% the initial value when lit at complete direct current of the rated voltage in 25 °C environment)
Degree of Protection	IP65: Continuous Lighting □ IP54: Continuous Lighting, Flashing, Buzzer □ Pole Mount (with L-shaped bracket)-without L-shaped bracket □ IP23: Pole Mount (with L-shaped bracket)-with L-shaped bracket □ (IEC 60529) *
Flashing Cycle	approx. 105 cycles per minute (1.75Hz)
Sound Pressure (at 1m)	70~90 dB (3.3kHz)
Buzzer Cycle	Buzzer 1: approx. 700 cycles per minute Buzzer 2: approx. 35 cycles per minute
Buzzer Power Consumption	110mA
Buzzer Inrush Current	250mA max.(DC), 400mA max.(AC)

\*1 □ The highest temperature is limited to 50 °C when all tiers are lit continuously in the following combinations:  
 □ □ Two or more tiers including blue and green (Example: Red-Green-Blue, Green-Green-Red)  
 □ □ Four or five tiers (Example: Red-Yellow-Green-Pure White, Red-Yellow-Blue-Green-Pure White)  
 \*2 Note that the durability of the LED is greatly affected by the operating conditions.  
 □ Note that the durability of the LED and Buzzer is greatly affected by the operating conditions.

3 Mounting

- See the figure on the upper right for the installation of the LD6A series.
- For details on mounting holes, see Mounting Hole Layout.
- In order to make the buzzer sound more effective, face the unit to the front. (Continuous Lighting, Flashing, Buzzer)

●Frame Mount

- Insert two frame nuts in the frame, and attach the bracket using two M5 screws. Recommended tightening torque: 2.6 to 2.7 N·m
- Mount the LD6A to the bracket using four M4 screws. Recommended tightening torque: 1.6 to 1.7 N·m

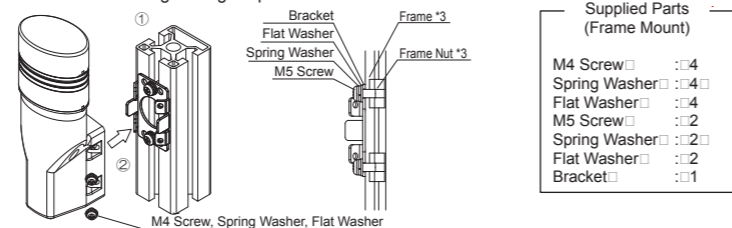

Supplied Parts (Frame Mount)

M4 Screw □	□4
Spring Washer □	□4
Flat Washer □	□4
M5 Screw □	□2
Spring Washer □	□2
Flat Washer □	□2
Bracket □	□1

\*3 See below for typical examples of Frames and Nuts. Consult the manufacturer for the installation method of the frame nut.

Examples of recommended frames and frame nuts

Frame Size	Frame	Frame Nut	Manufacturer
□30 mm *4	SFF-302	SFB-001 SFB-4B5 SFB-101	SUS Corporation
□40 mm	SFF-402	SFB-008 SFB-4A5 SFB-108	SUS Corporation

\*4 When using a □30 mm frame, the LD6A body protrudes from the frame.

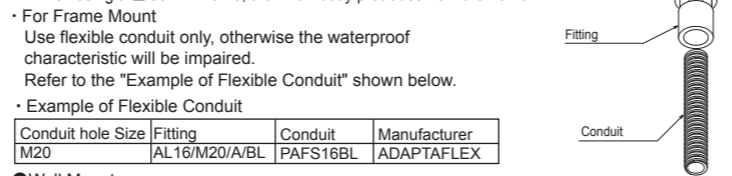

●Wall Mount

- Make four tapped holes in the mounting panel, and mount the bracket and gasket using four screws (M4 x 20). Recommended tightening torque: 1.6 to 1.7 N·m
- Mount the LD6A to the bracket using four screws (M4 x 8). Recommended tightening torque: 1.6 to 1.7 N·m

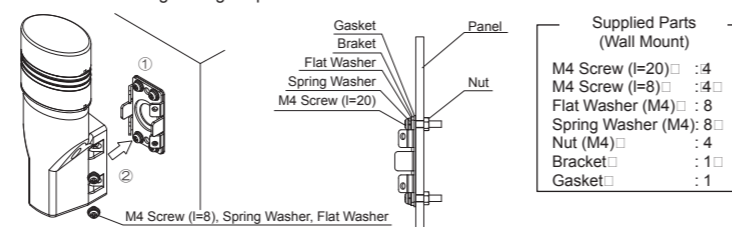

Supplied Parts (Wall Mount)

M4 Screw (L=20) □	□4
M4 Screw (L=8) □	□4
Flat Washer (M4) □	□8
Spring Washer (M4) □	□4
Nut (M4) □	□4
Bracket □	□1
Gasket □	□1

●Direct Mount

Recommended tightening torque: 2.6 to 2.7 N·m

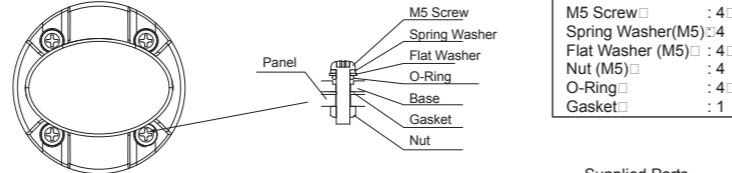

Supplied Parts (Direct Mount)

M5 Screw □	□4
Spring Washer(M5) □	□4
Flat Washer (M5) □	□4
Nut (M5) □	□4
O-Ring □	□4
Gasket □	□1

●Pole Mount

The pole mount type can be installed in four ways. The recommended mounting method is described below.

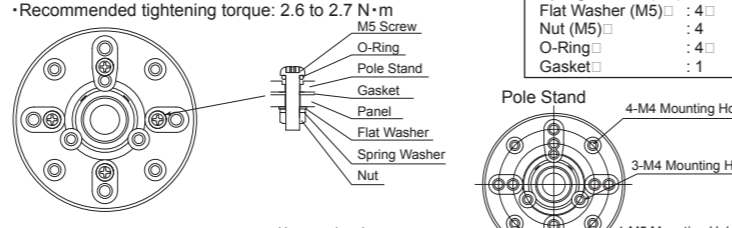

Supplied Parts (Pole Mount)

M5 Screw □	□4
Spring Washer (M5) □	□4
Flat Washer (M5) □	□4
Nut (M5) □	□4
O-Ring □	□4
Gasket □	□1

●Pole Mount (with stand)

- Installing without L-shaped bracket: Remove the bushing, hexagonal nut (M22), plain washer, and L-shaped bracket from the pole. Install in order of plain washer, hexagonal nut (M22), and bushing as shown in the figure at the right.
- Recommended tightening torque(M10): 10 to 11 N·m
- Recommended tightening torque(M22): 25 to 26 N·m
- The parts marked with \* are not supplied and should be prepared by the user.

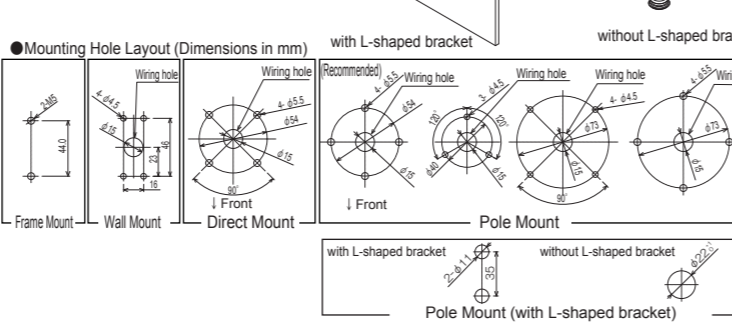

▲ CAUTION

- Mount the LD6A light on a flat surface not subjected to vibrations.
- Do not mount the LD6A light upside-down or horizontally.
- Do not leave the LD6A unit without a cap or unassembled. (recommended tightening torque: 1.1 to 1.2 N·m)
- Install the supplied gasket, otherwise waterproof characteristic is impaired.
- Mount the LD6A light on a flat surface, otherwise waterproof characteristic is impaired.
- Do not apply any chemicals which may corrode the plastic material.
- Debur the wiring holes.
- Do not loosen the screws for which tightening torque is not specified.
- If the LD6A light is subjected to strong vibrations, the hexagon socket set screws may become loose. Apply screw lock paint. See the figure at right.

4 Assembling the LED Units

- Turn off the power.
- Remove the cap. Insert a flat screwdriver into the slot. Use a screwdriver 1-mm thick and 7-mm wide maximum.
- Pull out the cap by hand.
- Loosen the screw in center.
- Rearrange the LED units.
- When assembling the LED unit, make sure to align the recess of the cap with the recess of the LED unit. Otherwise, damage may result.
- Screw tightening torque: 0.4 to 0.5 N·m

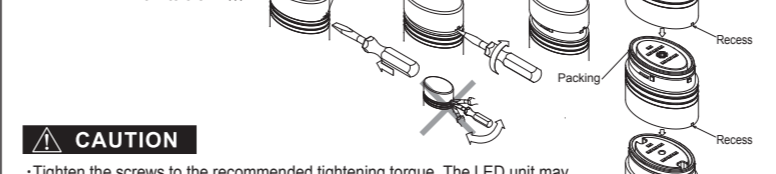

▲ CAUTION

- Tighten the screws to the recommended tightening torque. The LED unit may be damaged if the screw is loose during operation.
- Do not touch the metal tabs of the LED unit. When a hand touches the metal tabs, static electricity may damage the LED elements inside.
- Use a maximum of 5 tiers.
- Use an appropriate screw depending on the number of tiers. (optional)
- Note the correct orientation when assembling the LED units.
- Do not remove the packing from the LED unit. Waterproof characteristics will be impaired.

5 Sound pressure adjustment (Continuous Lighting, Flashing, Buzzer)

Move the sound pressure lever to the right and left to adjust the sound pressure. The sound pressure is at maximum when the lever is set to the right. (See figure at the right)

▲ CAUTION

The sound pressure adjustment lever may be damaged if it is forcibly moved.

6 Wiring

▲ CAUTION

- Connect the wires as shown below. Incorrect wiring may damage the internal circuit.
- Connect the wires to external contacts as needed for the number of tiers.
- When using four tiers or less, insulate the unused wires.
- Connect an appropriate fuse to the power line as shown in the figure below.
- Use a UL listed external fuse holder.
- Use a Class 2 power supply only.
- When using the same color for two or more tiers, only one wire is used to light all tiers of the same color.
- Determine the contact capacity in consideration of the LED rated current.
- Do not apply voltage to flashing (brown) lines.
- Do not connect flashing (brown) lines with power lines. The internal circuit may be damaged.
- Do not turn on the continuous lighting and flashing contacts simultaneously. Use separate outside contacts.
- When operating several continuous lighting, flashing, buzzer type units simultaneously, use separate outside □ contacts.
- When using buzzers 1 and 2 simultaneously, use separate outside contacts for continuous lighting and buzzer □ type units respectively.

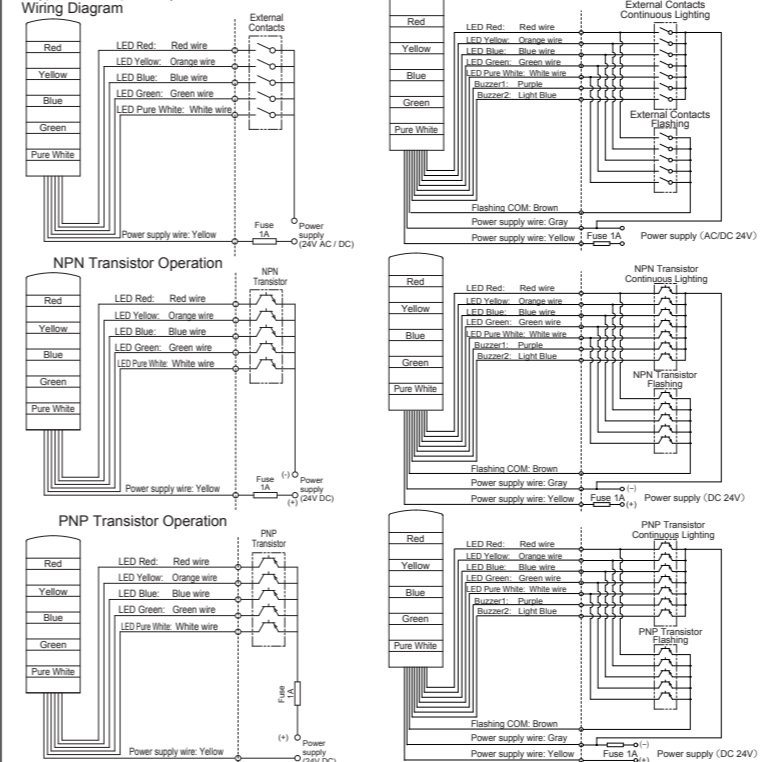

Wire Color	Wire Color	Wire Color	Wire Color
LED Unit Color - Red	Red	LED Unit Color - Red	Red
LED Unit Color - Yellow	Orange	LED Unit Color - Yellow	Orange
LED Unit Color - Blue	Blue	LED Unit Color - Blue	Blue
LED Unit Color - Green	Green	LED Unit Color - Green	Green
LED Unit Color - Pure White	White	LED Unit Color - Pure White	White
Power supply wire	Yellow	Buzzer1	Purple
		Buzzer2	Light Blue
		Flashing	Brown
		Power supply wire	Gray
		Power supply wire	Yellow

Rated Contact for Continuous Lighting			Rated Contact for Buzzer		
Contact Capacity for AC (per one tier)	Current Capacity	100 mA minimum	Contact Capacity for AC (per one sound)	Current Capacity	400 mA minimum
Contact Capacity for DC/ Transistor Rating (per one tier)	Dielectric Strength	AC 35V minimum	Contact Capacity for DC/ Transistor Rating (per one sound)	Current Capacity	300 mA minimum
	Leakage Current	0.1 mA maximum		Dielectric Strength	35V minimum □
				Leakage Current	0.1 mA maximum

7 Dimensions

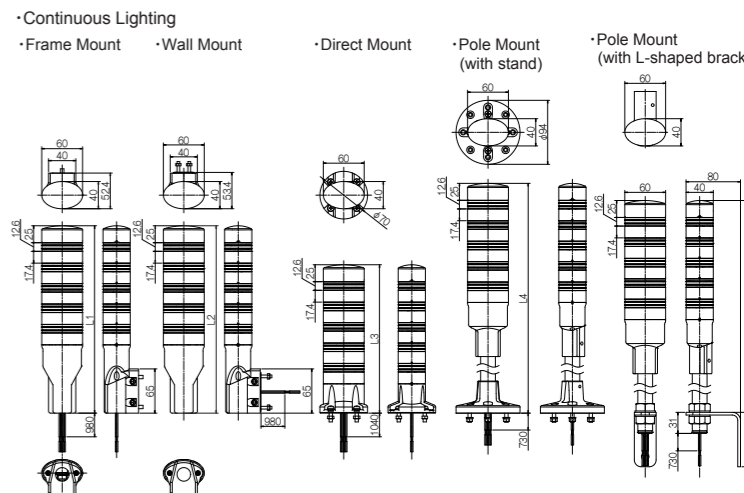

Dimensions

Tiers	Pole Mount (with stand)		Pole Mount (with L-shaped bracket)	
	(L1)	(L2)	(L3)	(L4)
1 □	156 □	156 □	98 □	408 □
2 □	186 □	186 □	128 □	438 □
3 □	216 □	216 □	158 □	468 □
4 □	246 □	246 □	188 □	498 □
5 □	276 □	276 □	218 □	528 □

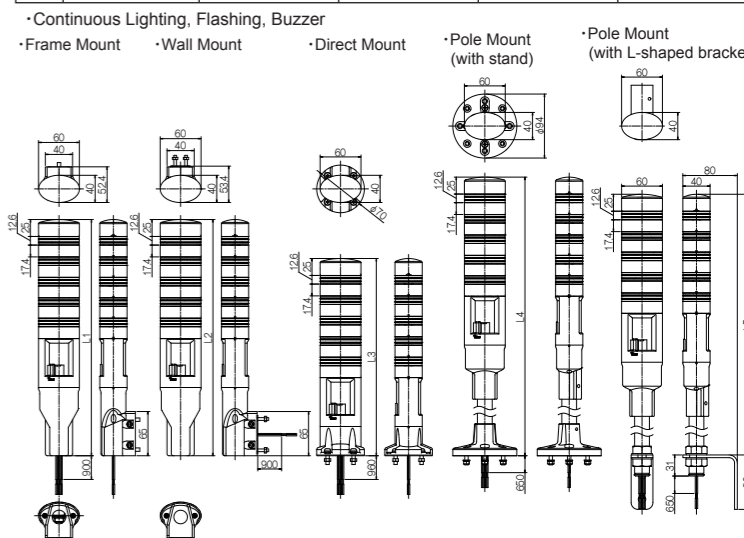

Dimensions

Tiers	Pole Mount (with stand)		Pole Mount (with L-shaped bracket)	
	(L1)	(L2)	(L3)	(L4)
1 □	228 □	228 □	170 □	480 □
2 □	258 □	258 □	200 □	510 □
3 □	288 □	288 □	230 □	540 □
4 □	318 □	318 □	260 □	570 □
5 □	348 □	348 □	290 □	600 □

7 Precautions for Disposal

- Dispose of the LD6A Series as an industrial waste.